

## INDEX

<b>1. GENERAL INFORMATION</b> .....	<b>1</b>
1.1. General description of the SAFEasy™ safety light curtains .....	1
1.2. New features with respect to the SE series .....	3
1.3. How to choose the device .....	4
1.4. Typical applications .....	6
1.5. Safety information .....	7
<b>2. INSTALLATION MODE</b> .....	<b>8</b>
2.1. Precautions to be observed for the choice and installation of the device .....	8
2.2. General information on device positioning .....	9
2.2.1. <i>Minimum installation distance</i> .....	11
2.2.2. <i>Safety distance variation with Blanking function activated</i> .....	13
2.2.3. <i>Minimum distance from reflecting surface</i> .....	14
2.2.4. <i>Installation of several adjacent safety light curtains</i> .....	16
2.2.5. <i>Use of deviating mirrors</i> .....	17
<b>3. MECHANICAL MOUNTING</b> .....	<b>18</b>
<b>4. ELECTRICAL CONNECTIONS</b> .....	<b>20</b>
4.1. Only EDM models .....	20
4.2. Blanking models .....	21
4.3. Cascade models .....	22
4.4. Cascade/Blanking models .....	23
4.5. Notes on the connections .....	25
<b>5. ALIGNMENT PROCEDURES</b> .....	<b>29</b>
5.1. Correct alignment procedure .....	29
5.2. Alignment procedure in the Cascade configuration .....	32
<b>6. FUNCTIONING MODE</b> .....	<b>33</b>
6.1. Dip-switch functioning mode .....	33
6.2. Standard configuration .....	33
6.3. Restart mode .....	34
6.4. Reset function .....	36
6.5. EDM function .....	36
6.6. Blanking function .....	37
6.6.1. <i>Floating Blanking</i> .....	38
6.6.2. <i>Floating Blanking - 1 beam</i> .....	40
6.6.3. <i>Floating Blanking - 2 beams</i> .....	41
6.6.4. <i>Floating Blanking - upto 3 beams (reduced resolution)</i> .....	42
6.6.5. <i>Fixed Blanking</i> .....	43
6.6.6. <i>Fixed Blanking tolerance</i> .....	46
6.7. Cascade configuration .....	47
6.7.1. <i>Stand-Alone Master</i> .....	48
6.7.2. <i>Alignment</i> .....	48

**7. DIAGNOSTIC FUNCTIONS ..... 49**  
 7.1. Visualisation of the functions..... 49  
 7.2. Fault and diagnostic messages..... 50

**8. CHECKS AND PERIODICAL MAINTENANCE ..... 52**  
 8.1. Maintenance..... 52  
 8.2. General information and useful data ..... 53  
 8.3. Warranty..... 53

**9. TECHNICAL DATA ..... 54**

**10. LIST OF AVAILABLE MODELS ..... 55**

**11. DIMENSIONS ..... 58**

**12. ACCESSORIES ..... 59**

English

## 1. GENERAL INFORMATION

### 1.1. General description of the SAFEasy™ safety light curtains

The **SAFEasy™** safety light curtains of the SE4-PLUS series, are optoelectronic multibeam devices that can be used to protect working area that, in presence of machines, robots, and automatic systems in general, can become dangerous for operators that get in touch, even accidentally, with moving parts.

The **SAFEasy™** light curtains of the SE4-PLUS series are Type 4 intrinsic safety systems used as accident-prevention protection devices and are manufactured in accordance with the international Standards in force for safety, in particular:

<b>IEC 61496-1: 2004</b>	Safety of machinery: electro-sensitive protective equipment. Part 1: General requirements and tests.
<b>CEI IEC 61496-2: 1997</b>	Safety of machinery: electro-sensitive protective equipment. Particular requirements for equipment using active optoelectronic protective devices.

The device, consisting in one emitting and one receiving units housed inside strong aluminium profiles, generates an infrared beam array that detects any opaque object positioned within the light curtain detection field.

The emitting and the receiving units are equipped with the command and control functions. The connections are made through a M12 connector located in the lower side of the profile.

The synchronisation between the emitter and the receiver takes place optically, i.e. no electrical connection between the two units is required.

The microprocessors guarantee the check and the management of the beams that are sent and received through the units: the microprocessors – through some LEDs – inform the operator about the general conditions of the light curtain and about eventual faults (see section 7 “Diagnostic functions”).

During installation, two yellow LEDs facilitate the alignment of both units (see section 5 “Alignment procedures”).

As soon as an object, a limb or the operator’s body accidentally interrupts the beams sent by the emitter, the receiver immediately opens the OSSD output and blocks the machine (if correctly connected to the OSSD).

**Note:** The following abbreviations, defined by the Standards in force, will be used in this manual:

**AOPD** *Active opto-electronic protective device*

**ESPE** *Electro-sensible protective equipment*

**OSSD** *Output signal switching device (switching output)*

**TX** *Emission device*

**RX** *Receiving device*



Some parts or sections of this manual containing important information for the operator are preceded by a note:



Notes and detailed descriptions about particular characteristics of the **SAFEasy™** safety devices in order to better explain their functioning; special instructions regarding the installation process.

The information provided in the paragraphs following this symbol is very important for safety and may prevent accidents.

Always read this information accurately and carefully follow the advice to the letter.

This manual contains all the information necessary for the selection and operation of the **SAFEasy™** safety devices.

However, specialised knowledge not included in this technical description is required for the planning and implementation of a safety light curtain on a power-driven machine.

As the required knowledge may not be completely included in this manual, we suggest the customer to contact DATASENSOR Sales Technical Service for any necessary information relative to the functioning of the SE4-PLUS series light curtains and the safety rules that regulate the correct installation (see section 8 “Checks and periodical maintenance”).

### 1.2. New features with respect to the SE series

With respect to the basic SE series, the SE4-PLUS safety light curtains present the following new features:

- the entire series is composed of Type 4 safety light devices
- introduction of the EDM function on all models
- availability of models with Floating and Fixed Blanking
- Cascade configuration possibility of two safety light curtains in master-slave mode
- SE4-PLUS series does not include models with the Muting function
- SE4-PLUS series does not include models for body protection.

The aforementioned functions have not been implemented in all the models. The following table lists the possible combinations available in the models of the SE4-PLUS\* series:

Model	Resolution	EDM	Blanking	Cascade
<i>EDM</i> Finger Protection	14mm	x		
<i>EDM</i> Hand Protection	30mm	x		
<i>Blanking</i> Finger Protection	14mm	x	x	
<i>Blanking</i> Hand Protection	30mm	x	x	
<i>Cascade</i> Finger Protection	14mm	x		x
<i>Cascade</i> Hand Protection	30mm	x		x
<i>Cascade&amp;Blanking</i> Finger Protection**	14mm	x	x	x
<i>Cascade&amp;Blanking</i> Hand Protection**	30mm	x	x	x

\* please refer to specific section (section 10 "List of available models") for the complete list of all the models available with relative order code and description.

\*\* the Blanking function, in the Cascade & Blanking models, is available only in the master unit.

1.3. How to choose the device

There are at least three different main characteristics that should be considered when choosing a safety light curtain:

- **The resolution** strictly depending on the part of the body to be protected.

R = 14mm

Finger protection



20mm ≤ R ≤ 40mm

Hand protection



The resolution of the device is the minimum dimension, which an opaque object must have in order to obscure at least one of the beams that constitute the sensitive area.

As shown in Fig.1, the resolution only depends on the geometrical characteristics of the lenses, diameter and distance between centres, and is independent of any environmental and operating conditions of the safety light curtain.

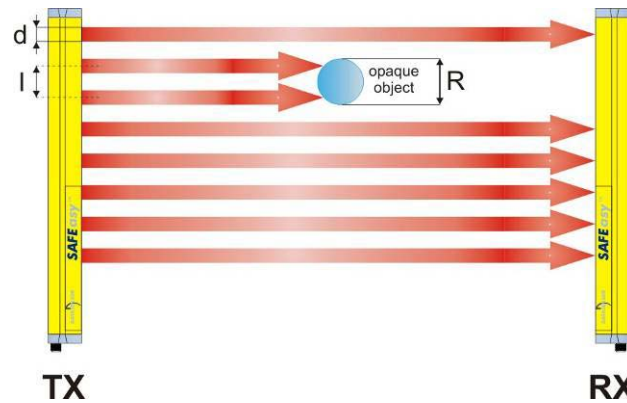

Fig. 1

The resolution value is obtained applying the following formula:

$$R = l + d$$

English

- **The height of the protected area**

It is important to distinguish between “Height of the sensitive area” and “Height of the controlled area” (see Fig.2).

- The height of the sensitive area is the distance between the lower and the upper limits respectively of the first and the last lens.
- The height of the controlled area is the effectively protected area. It delimits the area where an opaque object with larger or equal dimensions respect to the resolution of the safety light curtain may certainly cause the interruption of a beam.

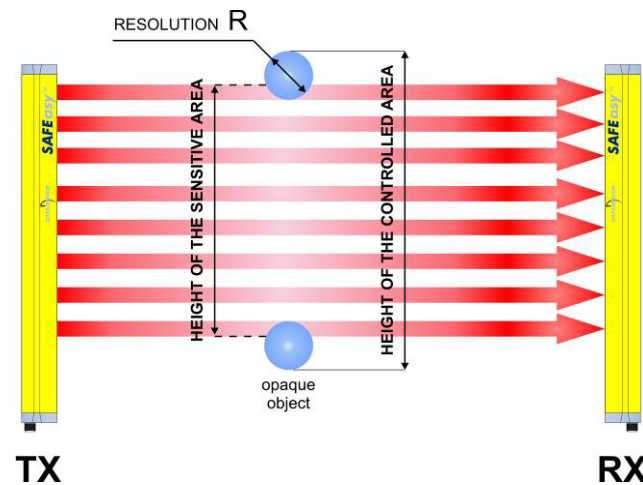

Fig. 2

- **The safety distance**

It is important to carefully calculate the distance between the point where the safety device will be placed and the possible danger associated with the machine to be protected (see section 2 “Installation mode” for the calculation of the safety distance).

#### 1.4. Typical applications

The **SAFEasy™** safety light curtains of the SE4-PLUS series are used in all automation fields where the control and protection of access to dangerous zones is necessary.

In particular they are used to stop the moving mechanical parts of:

- Automatic machines
- Packaging machines, handling machines, storing machines
- Wood working machines, glass working machines, ceramics working machines, etc.
- Automatic and semi-automatic assembly lines
- Automatic warehouses
- Presses, punching machines, benders and cutters



In food industry applications, DATASENSOR Technical Service has to verify the compatibility of the material of the safety light curtain housing with any chemical agents used in the production process.

The following pictures show some main applications.

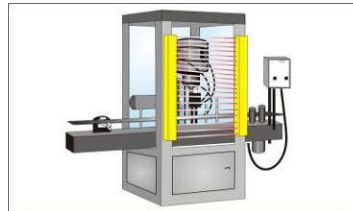

*Automatic packaging machines*



*Presses and punching machines*

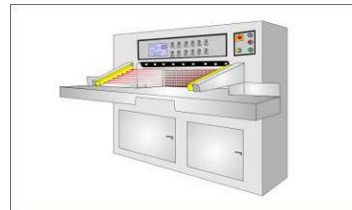

*Benders and cutters*

### 1.5. Safety information



The following precautions must be respected for a correct and safe use of the **SAFEasy™** safety device of the SE4-PLUS series:

- The stopping system of the machine must be electrically controllable.
- This control system must be able to instantly stop the dangerous movement of the machine during all the phases of the working cycle.
- Mounting and connection of the safety light curtain must only be carried out by qualified personnel, according to the indications included in the special sections (*refer to sections 2; 3; 4; 5; 6*).
- The safety light curtain must be securely placed in a particular position so that access to the dangerous zone is not possible without the interruption of the beams (*see section 2 "Installation mode"*).
- The personnel operating in the dangerous area must be well trained and must have adequate knowledge of all the operating procedures of the safety light curtain.
- The TEST/START and TEACH-IN push-buttons must be located outside the protected area as the operator has to check the protected area during all the Reset, Test and Teach-in operations.
- The TEACH-IN push-button, if pressed at powering or after the time-out period during functioning, provokes the safety block condition of the light curtain.
- The Blanking function is signalled, when activated, by a specific lamp positioned inside the transparent cap on the top of the RX unit.
- The minimum installation distance has to be recalculated if Floating Blanking is activated, consequently to the resolution reduction generated by this function (*see section 6 "Functioning mode"*). In order to guarantee the correct safety function, the requirements indicated in section 2.2.1 have to be carefully respected. Please note that the lamp has only a signalling function and is not a safety requirement.
- The function of the external device monitoring (EDM) is active only if the specific wire is correctly connected to the device.  
Please carefully read the instructions for the correct functioning before powering the light curtain.

## 2 INSTALLATION MODE

### 2.1. Precautions to be observed for the choice and installation of the device



- Make sure that the protection level assured by the SAFEasy™ (Type 4) is compatible with the real danger level of the machine to be controlled, according to EN 954-1.
- The outputs (OSSD) of the ESPE must be used as machine stopping devices and not as command devices. The machine must have its own START command.
- The dimension of the smallest object to be detected must be larger than the resolution level of the ESPE.
- The ESPE must be installed respecting the technical characteristics indicated in section 9.
- Do not place the device, in particular the receiving unit, near intense or blinking light sources.
- Strong electromagnetic interferences can compromise the correct functioning of the device. DATASENSOR suggests contacting its own Technical Service when this problem occurs.  
The operating distance of the device can be reduced by 50% in the presence of smog, fog or airborne dust.
- A sudden change in environment temperature, with very low minimum peaks, can generate a small condensation layer on the lenses and so jeopardise functioning.

English

## 2.2. General information on device positioning

The device should be carefully positioned, in order to reach a very high protection standard. Access to the hazardous area must only be possible by passing through the protecting safety light beams. Fig.3a shows some examples of possible access to the machine from the top and the bottom sides. These situations may be very dangerous so and so the installation of the safety light curtain at sufficient height in order to completely cover the access to the dangerous area (Fig.3b) becomes necessary.

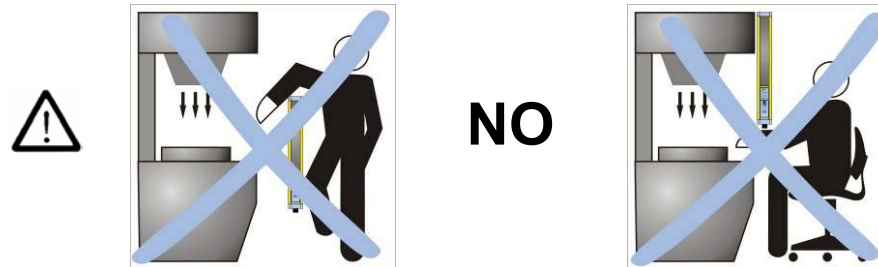

Fig. 3a

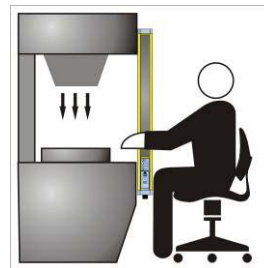

Fig. 3b

In normal operating conditions, machine starting must not be possible while operators are inside the hazardous area. When the installation of the safety light curtain very near to the dangerous area is possible, a second light curtain must be mounted in a horizontal position in order to prevent any lateral access (as shown in Fig.4b).

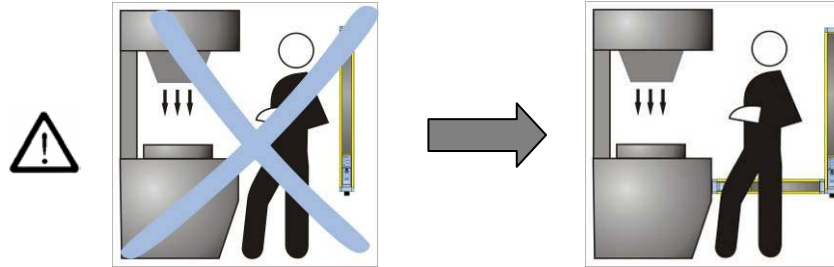

Fig. 4

Fig. 4b

English



If the operator is able to enter the dangerous area and is not detected by the beams, an additional mechanical protection must be mounted to prevent the access.

### 2.2.1. Minimum installation distance

The safety device must be placed at a specific safety distance (Fig.5).

This distance must ensure that the dangerous zone cannot be reached before the dangerous motion of the machine has been stopped by the ESPE.

The safety distance depends on 4 factors, according to the EN-999, 775 and 294 Standards:

- 1 Response time of the ESPE (the time between the effective beam interruption and the opening of the OSSD contacts).
- 2 Machine stopping time (the time between the effective opening of the contacts of the ESPE and the real stop of the dangerous movement of the machine).
- 3 ESPE resolution
- 4 Approaching speed of the object to be detected.

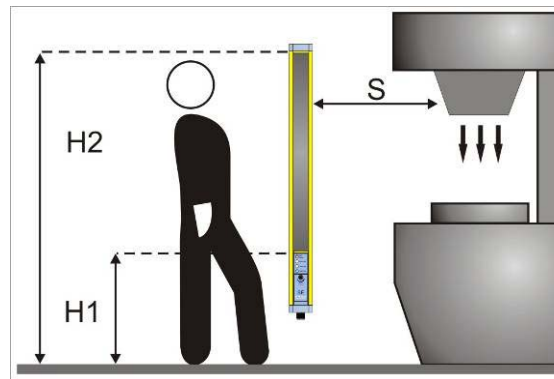

Fig. 5

The following formula is used for the calculation of the safety distance:

$$S = K (t_1 + t_2) + C$$

where:

- S** = Minimum safety distance in mm.
- K** = Speed of the object, limb or body approaching the dangerous area in mm/sec.
- t<sub>1</sub>** = Response time of the ESPE in seconds  
(see section 9 "Technical data")
- t<sub>2</sub>** = Machine stopping time in seconds.
- d** = Resolution of the system.
- C** = **8 (d -14)** for device with resolution ≤ 40mm

**Note:** The value of K is:

**2000 mm/s if the calculated value of S is  $\leq$  500 mm**

**1600 mm/s if the calculated value of S is  $>$  500 mm**

If the safety light curtain must be mounted in a horizontal position (Fig.6), the distance between the dangerous area and the most distant optic beam must be equal to the value calculated using the following formula:

$$S = 1600 \text{ mm/s } (t_1 + t_2) + 1200 - 0.4 H$$

where:

**S** = Minimum safety distance in mm

**t<sub>1</sub>** = Response time of the ESPE in seconds  
(see section 9 "Technical data")

**t<sub>2</sub>** = Machine stopping time in seconds

**H** = Beam height from ground.

This height must always be less than 1000 mm.

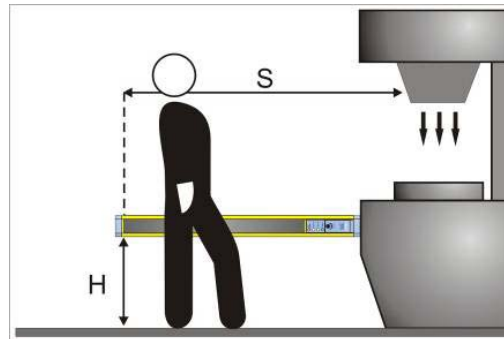

Fig. 6

English

### 2.2.2. Safety distance variation with Blanking function activated



The activation of the *Floating Blanking* function generates a resolution reduction of the device.

Consequent to this reduction, signalled also by the device signalling lamp (see section 6.6 "*Blanking function*"), the light curtain has to be repositioned at the right safety distance according to the indications supplied in the previous section and complying with the real device resolution.

The following table summarises the resolution variation in all possible applications:

Declared resolution	Real resolution with Floating Blanking		
	1 beam	2 beams	3 beams
14 mm	21 mm	28 mm	35 mm
30 mm	48 mm	66 mm	84 mm

### 2.2.3. Minimum distance from reflecting surface

Reflecting surfaces placed near the light beams of the **SAFEasy™** device (over, under or laterally) can cause passive reflections. These reflections can compromise the recognition of an object inside the controlled area (Fig.7)

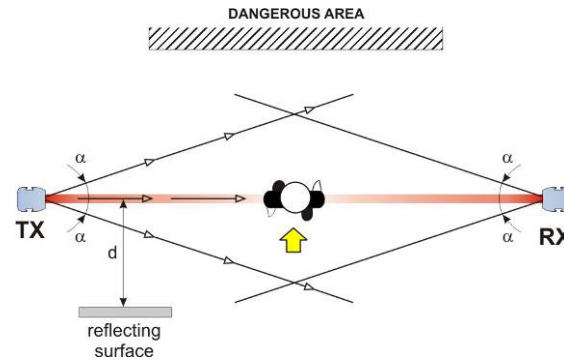

Fig. 7

However, if the **RX** receiver detects a secondary beam (reflected by the side-reflecting surface) the object might not be detected, even if the object interrupts the main beam.

English

It is thus important to position the safety light curtain according to the minimum distance from any reflecting surface.

The minimum distance depends on:

- Operating distance between emitter (TX) and receiver (RX);
- Maximum opening angle of the light beam sent by the safety light curtain, depending on the type of the device; in particular:
  - 5° for ESPE Type 4 ( $\pm 2.5^\circ$  as to the optic axis);

The graphic in Fig.8 shows the data of the minimum distance.

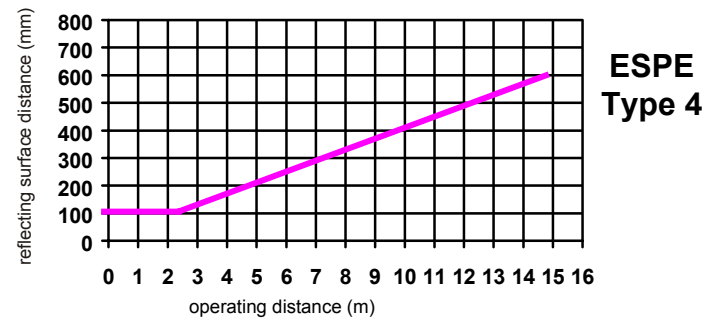
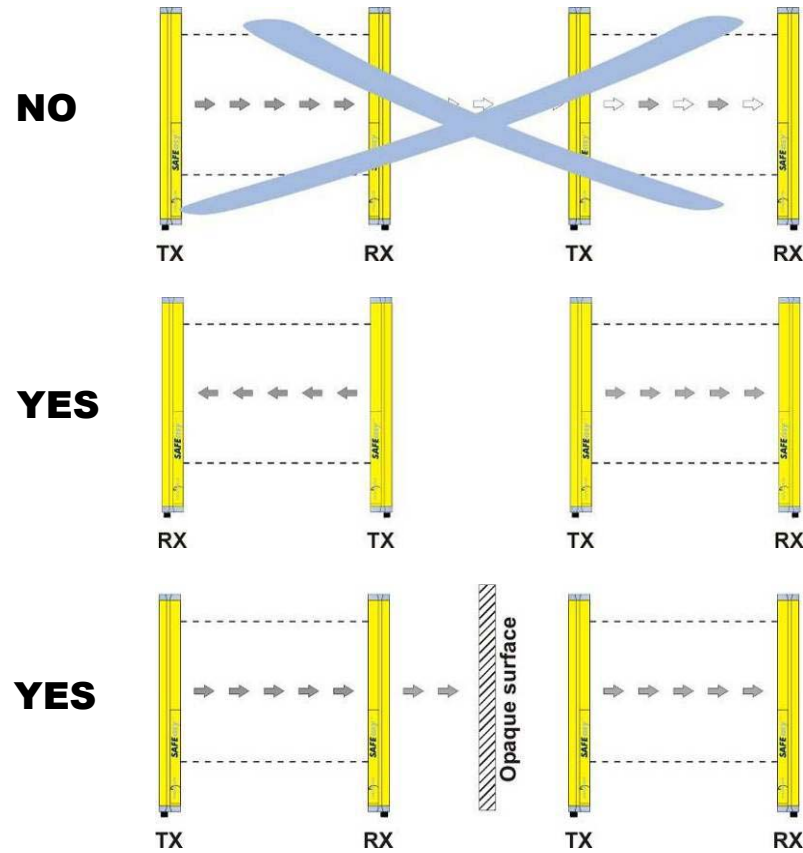

Fig. 8

2.2.4. Installation of several adjacent safety light curtains

When several safety devices must be installed in adjacent areas, interferences between the emitter of one device and the receiver of the other must be avoided.

Fig.9 provides an example of possible interferences between different devices and two pertinent solutions.



English

Fig. 9

### 2.2.5. Use of deviating mirrors

The control of any dangerous area, with several but adjacent access sides, is possible using the linear version without integrated Muting sensors and well-positioned deviating mirrors (see section 12 "Accessories").

Fig.10 shows a possible solution to control three different access sides, using two mirrors placed at a 45° angle respect to the beams.

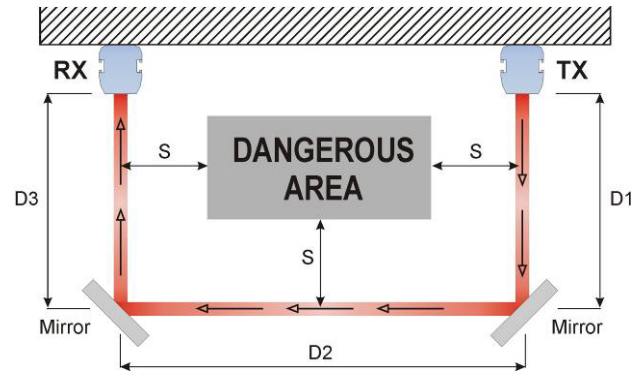

**Fig. 10**

The operator must respect the following precautions when using the deviating mirrors:

- The alignment of the emitter and the receiver can be a very critical operation when deviating mirrors are used. Even a very small angular displacement of the mirror is enough to lose alignment. A laser pointer (available as an accessory) can be used to avoid this problem.
- The minimum safety distance (S) must be respected for each single section of the beams.
- The effective operating range decreases by about 15% by using only one deviating mirror, the percentage further decreases by using 2 or more mirrors (for more details refer to the technical specifications of the mirrors used).
- Do not use more than three mirrors for each device.
- The presence of dust or dirt on the reflecting surface of the mirror causes a drastic reduction in the range.

### 3. MECHANICAL MOUNTING

The emitting (TX) and receiving (RX) units must be installed with the relevant sensitive surfaces facing each other. The connectors must be positioned on the same side and the distance must be included within the operating range of the model used (see section 9 “Technical data”).

Once positioned the two units, the two bars should be aligned and parallel as much as possible.

The next step, if necessary, is the fine alignment, as shown in section 5 “Alignment procedures”.

To mount the device, use the threaded pins supplied, inserting them into the slots on the two bars (Fig. 11)

The operator can use the pins and/or the rigid mounting brackets – supplied with the device – depending on the particular application and/or the type of support on which the two bars must be mounted (see Fig.12).



Fig. 11

English



Fig. 12

Rigid fixing brackets can be used where no large mechanical compensation is required during the alignment operation.

The rotating supports for the correction of the bar inclination are available on request (see section 12 "Accessories").

In case of applications with particularly strong vibrations, anti-vibration shock absorbers, together with threaded pins, rigid brackets and/or rotating supports, are recommended to reduce the impact of the vibrations,

The recommended mounting positions according to the safety light curtain length are shown in the following drawings and table:

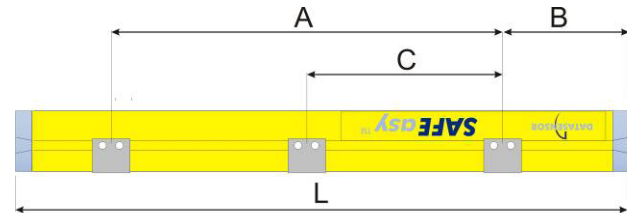

Model	L (mm)	A (mm)	B (mm)	C (mm)
SE4-xx-015-PP-y	246	86	80	-
SE4-xx-030-PP-y	393	193	100	-
SE4-xx-045-PP-y	540	300	120	-
SE4-xx-060-PP-y	687	387	150	-
SE4-xx-075-PP-y	834	474	180	-
SE4-xx-090-PP-y	981	581	200	-
SE4-xx-105-PP-y	1128	688	220	-
SE4-xx-120-PP-y	1275	875	200	438
SE4-xx-135-PP-y	1422	1022	200	510
SE4-xx-150-PP-y	1569	1121	220	565
SE4-xx-165-PP-y	1716	1216	250	608

xx: resolution (14mm - 30mm)

y: model (EDM, Blanking, Cascade, Blanking)

## 4. ELECTRICAL CONNECTIONS

### 4.1. Only EDM models

#### RECEIVER (RX):

M12 8-pole connector

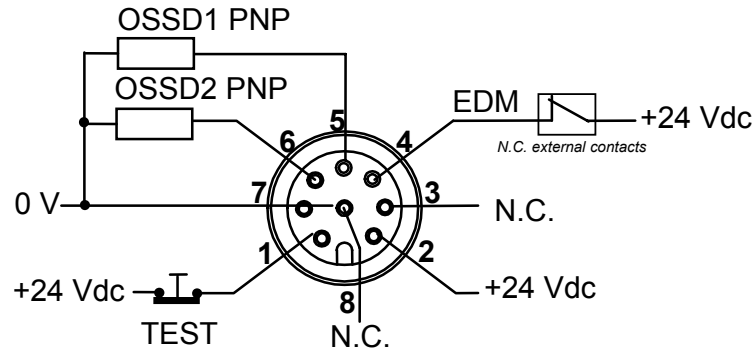

- 1 = white = TEST/START
- 2 = brown = +24 Vdc
- 3 = green = N.C.
- 4 = yellow = EDM
- 5 = grey = OSSD1
- 6 = pink = OSSD2
- 7 = blue = 0 V
- 8 = red = N.C.

#### EMITTER (RX):

M12 4-pole connector

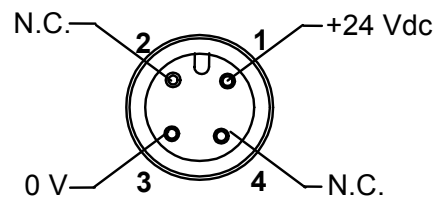

- 1 = brown = +24 Vdc
- 2 = white = N.C.
- 3 = blue = 0 V
- 4 = black = N.C.

English

## 4.2. Blanking models

**RECEIVER (RX):**

M12 8-pole connector

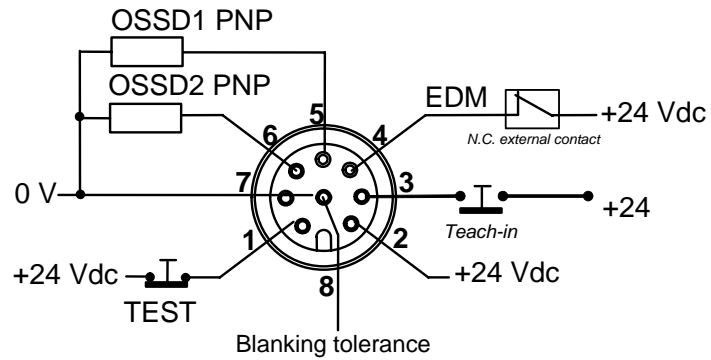

- |            |                      |
|------------|----------------------|
| 1 = white  | = TEST/START         |
| 2 = brown  | = +24 Vdc            |
| 3 = green  | = TEACH-IN           |
| 4 = yellow | = EDM                |
| 5 = grey   | = OSSD1              |
| 6 = pink   | = OSSD2              |
| 7 = blue   | = 0 V                |
| 8 = red    | = Blanking tolerance |

**EMITTER (RX):**

M12 4-pole connector

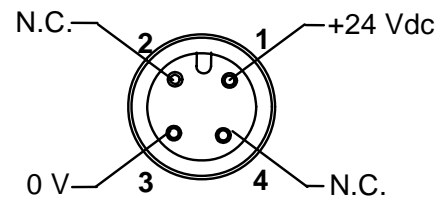

- |           |           |
|-----------|-----------|
| 1 = brown | = +24 Vdc |
| 2 = white | = N.C.    |
| 3 = blue  | = 0 V     |
| 4 = black | = N.C.    |

**4.3. Cascade models**

The models, that allow the Cascade configuration of the two light curtains, have two M12 connectors on both the Master/Slave units and a M12 connector on the Slave unit.

**MASTER RECEIVER (RX):**

M12 8-pole connector:

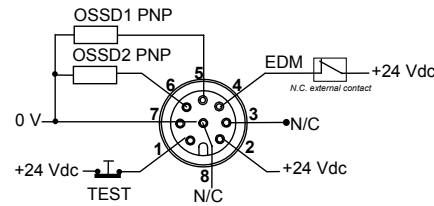

- 1 = white = TEST/START
- 2 = brown = +24 Vdc
- 3 = green = N/C
- 4 = yellow = EDM
- 5 = grey = OSSD1
- 6 = pink = OSSD2
- 7 = blue = 0 V
- 8 = red = N/C

M12 5-pole connector

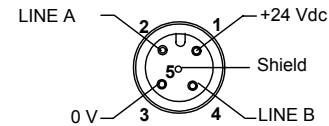

- 1 = brown = +24 Vdc
- 2 = white = LINE A
- 3 = blue = 0 V
- 4 = black = LINE B
- 5 = grey = Shield

English

**MASTER EMITTER (TX):**

M12 4-pole connector

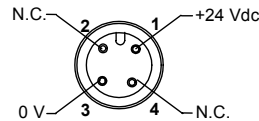

- 1 = brown = +24 Vdc
- 2 = white = NC
- 3 = blue = 0 V
- 4 = black = N/C

M12 5- pole connector

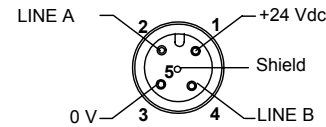

- 1 = brown = +24 Vdc
- 2 = white = LINE A
- 3 = blue = 0 V
- 4 = black = LINE B
- 5 = grey = Shield

**SLAVE RECEIVER (RX):**  
M12 5-pole connector

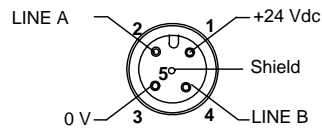

- 1 = brown = +24 Vdc
- 2 = white = LINE A
- 3 = blue = 0 V
- 4 = black = LINE B
- 5 = grey = Shield

**SLAVE EMITTER (TX):**  
M12 5-pole connector

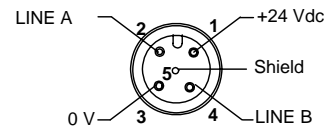

- 1 = brown = +24 Vdc
- 2 = white = LINE A
- 3 = blue = 0 V
- 4 = black = LINE B
- 5 = grey = Shield

**4.4. Cascade/Blanking models**

**MASTER RECEIVER (RX):**  
M12 8-pole connector

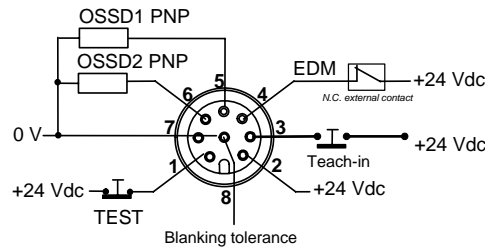

- 1 = white = TEST/START
- 2 = brown = +24 Vdc
- 3 = green = TEACH-IN
- 4 = yellow = EDM
- 5 = grey = OSSD1
- 6 = pink = OSSD2
- 7 = blue = 0 V
- 8 = red = Blanking tolerance

M12 5-pole connector

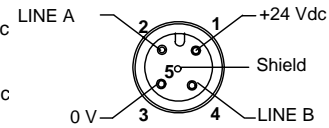

- 1 = brown = +24 Vdc
- 2 = white = LINE A
- 3 = blue = 0 V
- 4 = black = LINE B
- 5 = grey = Shield

**MASTER EMITTER (TX):**

M12 4-pole connector

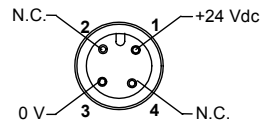

- 1 = brown = +24 Vdc
- 2 = white = NC
- 3 = blue = 0 V
- 4 = black = N/C

M12 5-pole connector

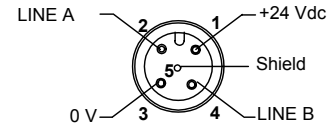

- 1 = brown = +24 Vdc
- 2 = white = LINE A
- 3 = blue = 0 V
- 4 = black = LINE B
- 5 = grey = Shield

**SLAVE RECEIVER (RX):**

M12 5-pole connector

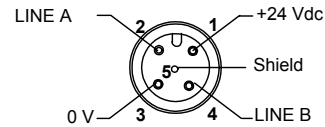

- 1 = brown = +24 Vdc
- 2 = white = LINE A
- 3 = blue = 0 V
- 4 = black = LINE B
- 5 = grey = Shield

**SLAVE EMITTER (TX):**

M12 5-pole connector

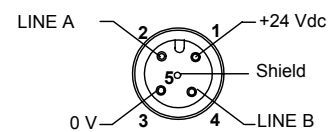

- 1 = brown = +24 Vdc
- 2 = white = LINE A
- 3 = blue = 0 V
- 4 = black = LINE B
- 5 = grey = Shield

English

#### 4.5. Notes on the connections

For the correct functioning of the **SAFEasy™** safety light curtains of the SE4-PLUS series, the following precautions regarding the electrical connections have to be respected:



- Use only shielded cables for the connection of the two units.
- The light curtain has been developed to offer an adequate immunity level against disturbances in the most critical working conditions.
- It is possible to connect to ground the device housing using the mechanical part supplied for ground connection (refer to configuration illustrated in Fig.13).

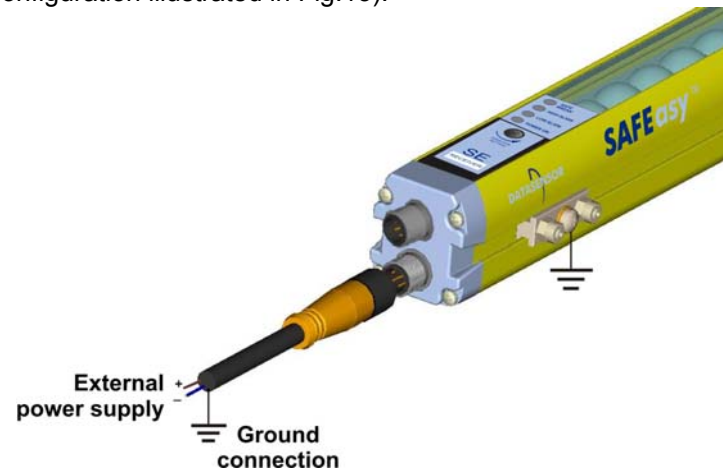



Fig. 13

- Do not place connection cables in contact or near high-voltage cables (e.g. motor power supplies, inverters, etc.);
- Do not connect in the same multi-pole cable the OSSD wires of different light curtains;
- The TEST/START wire must be connected through a N.C. button to the supply voltage of the ESPE. A daily manual test is necessary to verify the correct functioning of the safety light curtain. Press the specific button to activate the test.
- The TEST/START button must be located in such a way that the operator can check the protected area during any Test, Override and Reset operation. (see section 6 "Functioning mode").

- The TEST/START and TEACH-IN push-buttons must be located in such a way that the operator can check the protected area during any Test, Override and Reset operation. (see section 6 "Functioning mode").  

- The EDM wire has to be connected, before powering, to a 24 Vdc normally closed contact. The control function, if selected, will not be activated, at device powering, if the wire is not correctly connected. In this case the safety light curtain enters in an error status.
- The TEACH-IN wire, where available, can be connected to a 24 Vdc normally open contact (as per the TEST/START push-button). Carefully check that the push-button is not pressed at powering (and in any case the wire must not be connected to 24 Vdc); otherwise the light curtain enters in an error status.
- The device is equipped with overvoltage and overcurrent protection. The use of other external devices is allowed but not recommended.

English

The ground connection of the two units depends on the electrical protection class to be guaranteed (see section 9 "Technical Data" for more information).

This connection can be carried-out using the mechanical part supplied for ground connection (see Fig. 14).

Insert the support plate (M4x0.7 mm threaded holes) in one of the two slots visible laterally on the profile.

The two pins (M4x14) have to be screwed on the external support hole, leaving the central hole free.

We suggest to screw the pins using a Couple included between 2.2 and 2.5 Nm.

The Couple guarantees that the pin head passes through the paint allowing the contact with the metal housing.

Block the pins using the two M4 self-fixing nuts.

The nuts have to be tightened using a hexagonal CH.7 wrench.

The nuts avoid the unscrewing of the pins in presence of strong vibrations.

Insert the M4 ring and screw it on the central support hole.

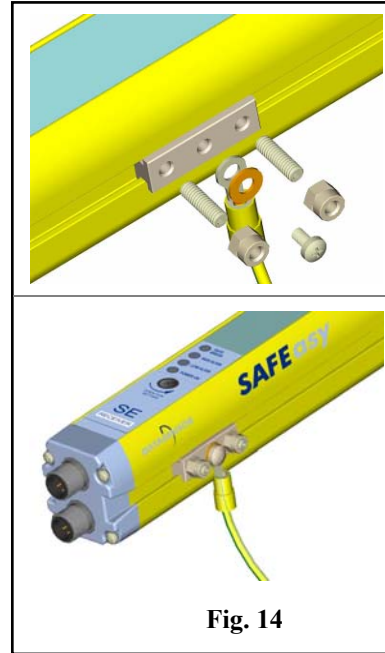

Fig. 14

- The OSSD1 and OSSD2 safety contacts cannot be connected in series or in parallel, but can be used separately (Fig.15). If one of these configurations is erroneously used, the device enters into the output failure condition (see cap.7 “Diagnostic functions”).
- Connect both OSSD to the activating device. The avoided connection of an OSSD to the activating device jeopardises the system safety degree that the light curtain has to control.

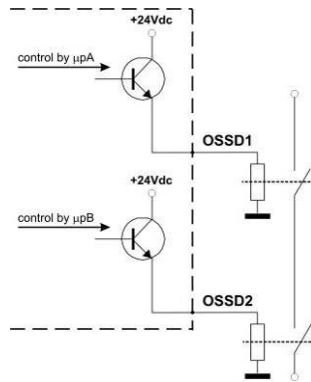

Fig. 15

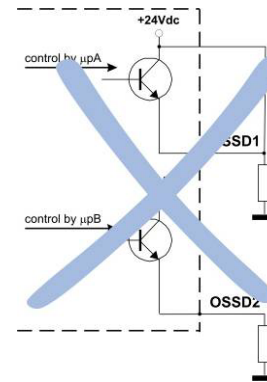

Fig. 16

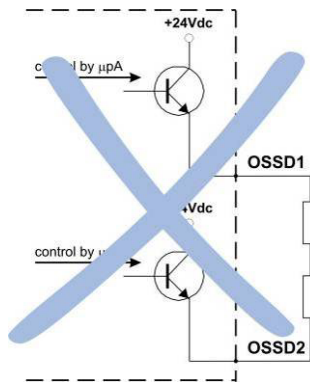

Fig. 17

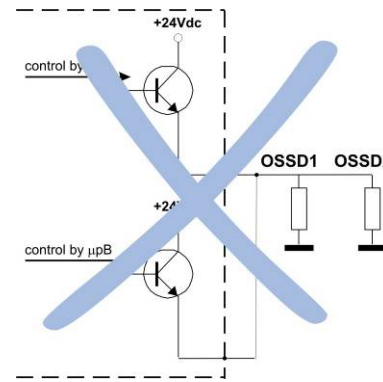

Fig. 18

English

## 5. ALIGNMENT PROCEDURES

The alignment between the emitting and the receiving units is necessary to obtain the correct functioning of the light curtain.

The alignment is perfect if the optic axes of the first and the last emitting unit's beams coincide with the optic axes of the corresponding elements of the receiving unit. Two yellow LED indicators (HIGH ALIGN, LOW ALIGN) facilitate the alignment procedure.

### 5.1. Correct alignment procedure

When the mechanical installation and the electrical connections have been effected – as explained in the previous paragraphs – it is possible to carry-out the alignment of the safety light curtain, according to the following procedure:

- Disconnect the power supply to SAFEasy™.
- Press the TEST/START button and keep it pressed (open the contact).
- Re-connect the power supply.
- Release the TEST/START button.
- Check the green LED on the bottom of the TX unit (POWER ON) and the yellow LED (SAFE); if they are ON, the unit is running correctly.
- Verify that one of the following conditions is present on the RX unit:
  - The green LED on the bottom is ON (POWER ON) and the light of the SAFE/BREAK LED on the top is red (BREAK): non-alignment condition.
  - The green LED on the bottom is ON (POWER ON) and the light of the SAFE/BREAK LED on the top is green (SAFE): alignment condition (in this case also the two intermediate yellow LED HIGH ALIGN, LOW ALIGN, are ON).

- Continue with the following steps to change from condition 1 to condition 2:
  - A** Keep the receiving unit in a steady position and set the emitting unit until the bottom yellow LED (LOW ALIGN) is ON. This condition shows the effective alignment of the first lower beam.
  - B** Rotate the emitting unit until the top yellow LED (HIGH ALIGN) is ON: in this condition. The top LED must change from BREAK to SAFE (from red to green).
  - C** For further details on the alignment degree, please refer to the SAFE/BREAK LED (*please refer to table at the end of this section*). The LED colour (red → low alignment degree/ green → high alignment degree) and the blinking frequency signal the alignment degree reached.

**Note:** The green LED powering, or blinking, is the necessary condition for alignment.

The safety light curtains, in some cases, can be aligned and normally functioning, even without the alignment procedure.

Ensure that the green light of the LED is ON and steady.

- D** Delimit the area in which the SAFE LED is steady through some small adjustments - for the first and then for the second unit - then place both units in the centre of this area.
- Fix the two units firmly using pins and brackets.
- Disconnect the power supply to **SAFEasy™**.
- Re-connect the power supply.
- Verify that the green LED is ON on the RX unit (condition where the beams are free, SAFE) and verify that the same LED turns red if even one single beam is obscured (condition where an object has been detected, BREAK).
- It is important to do this check using the specific cylindrical "Test Piece" which presents an adequate 14mm, 20mm, 30mm or 35mm diameter depending on the device used (*see section 12 "Accessories"*).

**Note:** When the Test Piece is passed from top to bottom, throughout the entire detection area at any distance between the two units, the red BREAK LED must always remain ON, without falsely switching.

A daily test is recommended.

LED Status	Diagnostics	Alignment degree
 <i>Red ON</i>  <i>OFF</i>  <i>OFF</i>  <i>Green ON</i>	First and last optics non-aligned.	 <p>0%</p> <p>100%</p>
 <i>Red ON</i>  <i>Yellow ON</i>  <i>OFF</i>  <i>Green ON</i>	First and last optics (from top) non-aligned.	
 <i>Red blinking</i>  <i>Yellow ON</i>  <i>Yellow ON</i>  <i>Green ON</i>	First and last optics non-aligned. Safe Break LED blinks at a F1 frequency. Red-coloured LED. Very low alignment.	
 <i>Red blinking</i>  <i>Yellow ON</i>  <i>Yellow ON</i>  <i>Green ON</i>	First and last optics non-aligned. Safe Break LED blinks at a F2 frequency higher than F1. Low alignment.	
 <i>Green blinking</i>  <i>Yellow ON</i>  <i>Yellow ON</i>  <i>Green ON</i>	Safe Break LED continues to blink at a F2 frequency, but the LED is now green. Medium alignment.	
 <i>Green blinking</i>  <i>Yellow ON</i>  <i>Yellow ON</i>  <i>Green ON</i>	Safe Break LED blinks again at a F1 frequency minor than F2. LED always green Good alignment.	
 <i>Green ON</i>  <i>Yellow ON</i>  <i>Yellow ON</i>  <i>Green ON</i>	Safe Break LED permanently ON.  All optics correctly aligned.	

## 5.2. Alignment procedure in the Cascade configuration

The alignment procedure of the single unit (Master or Slave) is not very different from the standard procedure described in section 5.1.

The LEDs, in the Cascade configuration, signal alignment only when the Master and Slave are both correctly aligned.

It is thus impossible to distinguish whether the single unit, Master or Slave, is not aligned correctly. We suggest consequently to divide the procedure in two different phases:

- **Master alignment:** carry-out the alignment procedure of only the Master unit according to the standard procedure (see section 5.1), connecting the specific electrical terminations instead of the Slave unit.

In presence of correct alignment, fix the Master and remove power supply.

Replace the electrical termination with the Master/Slave connection cables.

**Slave alignment:** the standard alignment procedure can now be carried-out for the Slave unit. Aligned correctly the Master unit, the operator is certain that all LED signals are referred to the Slave alignment.

## 6. FUNCTIONING MODE

### 6.1. Dip-switch functioning mode

A slot situated in the front side of the RX unit (Fig.19), that can be easily opened using a screwdriver, facilitates the access to the internal dip-switches for the configuration of the following functions:

- Floating Blanking
- EDM
- Reset mode



The device does not accept configuration changes during normal functioning. A change is accepted only beginning from the successive powering of the device.

Particular attention has to be taken during the configuration dip-switch management and use.

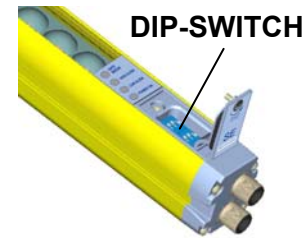

Fig. 19

dip-sw	Function	ON	OFF
1	Floating Blanking	<i>See section 6.6</i>	
2	Floating Blanking		
3	EDM	Deactivated	Activated
4	Reset	Automatic	Manual

### 6.2. Standard configuration

The device is supplied with the following standard configuration:

Model	EDM	Floating Blanking	Reset
EDM Finger Protection	deactivated	-	automatic
EDM Hand Protection	deactivated	-	automatic
Blanking Finger Protection	deactivated	deactivated	automatic
Blanking Hand Protection	deactivated	deactivated	automatic
Cascade Finger Protection	deactivated	-	automatic
Cascade Hand Protection	deactivated	-	automatic
Cascade&Blanking Finger Protection**	deactivated	deactivated	automatic
Cascade&Blanking Hand Protection**	deactivated	deactivated	automatic

**6.3. Restart mode**

An opaque object detected by the beams causes the switching of the OSSD outputs (i.e. the opening of the safety contacts - BREAK condition).

The restart of the ESPE (i.e. the closing of the OSSD safety contacts - SAFE condition) can be carried-out in two different ways:

**Automatic Restart:** when an opaque object is detected, the ESPE enters in the BREAK condition. Then, after the opaque object has been removed from the controlled area, the ESPE begins its normal functioning again.

**Manual Restart:** after the ESPE has detected an opaque object in the controlled area, the light curtain begins its normal functioning only by pressing the Restart button (TEST button) and after the object has been removed from the controlled area.

English

*Temporal diagram (Manual Restart)*

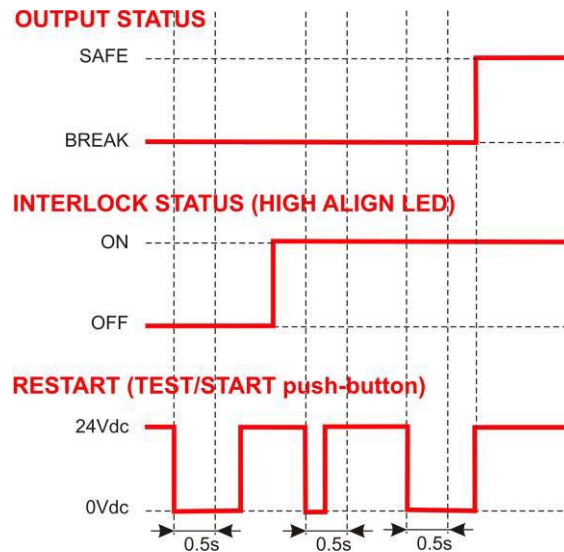

Fig. 20 shows the two functioning modes.

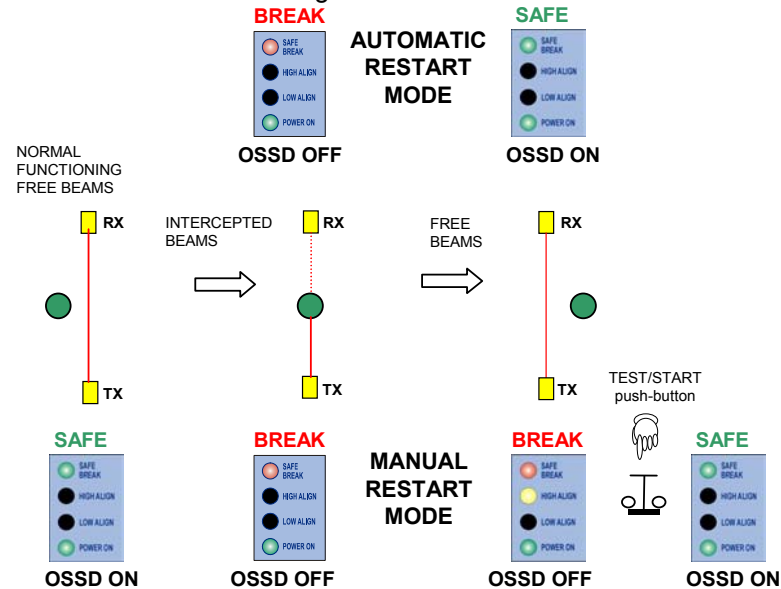
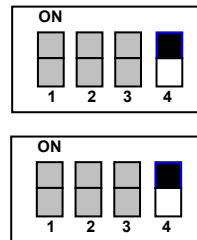

Fig. 20

The selection of the manual/automatic Restart mode is made through the dip-switches placed under the slot of the receiving unit.

In particular, the position 4 of both switches must be ON to activate the automatic Restart mode; OFF for the manual Restart mode.



**Note:** The dip-switches not used for this function are in grey. The lever position of the specific dip-switch is in black (ON) in the automatic Restart mode.

**6.4. Reset function**

The light curtain has a Reset function that is activated consequently to an internal failure. The operator has to press the TEST/START button resetting the break condition and thus return to normal functioning.

The button has to be kept pressed for at least 5 seconds in one of the following conditions:

- Output failure;
- Optic failure;
- EDM test function failure;
- Teach-in Blanking failure.

**Temporal diagram of the Reset function**

**Safety light curtain status**

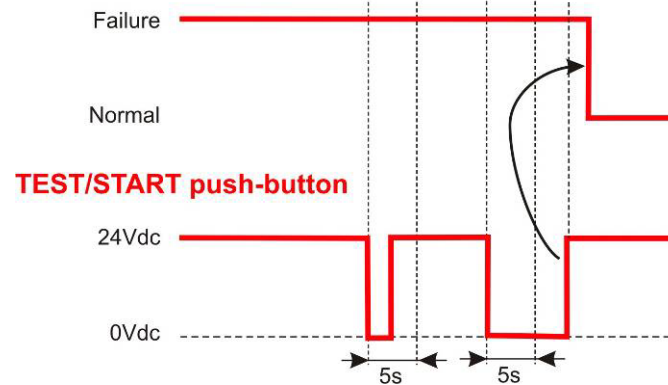

**6.5. EDM function**

The External devices monitoring (EDM) function controls external devices by verifying the OSSD status.

To correctly use this function:

- select it using the specific dip-switch;
- connect EDM input to the 24Vdc N.C. contact of the device to control.

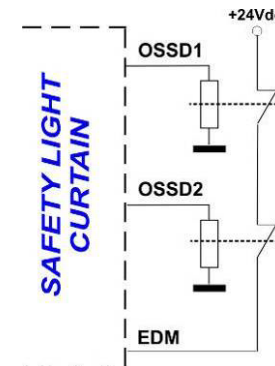

The function controls the N.C. contact switching according to the changes of the OSSD status.

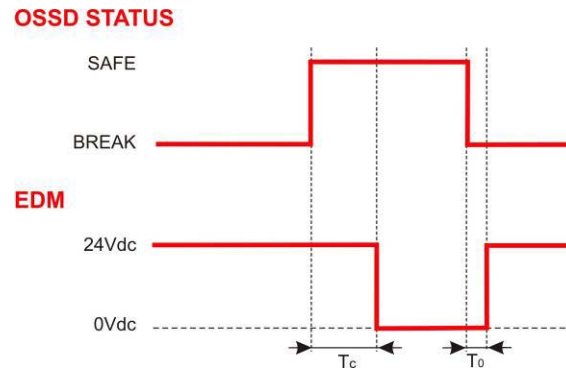

$T_c \geq 350$  msec time after the OSSD OFF-ON passage when EDM is carried-out

$T_0 \geq 100$  msec time after the OSSD ON-OFF passage when EDM is carried-out

The use of non-conform devices may cause failures.

The periodical testing of the function is recommended.

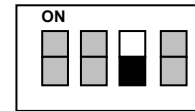

**The correct dip-switch positioning (dip 3 OFF) for the function activation is shown here aside.**

### 6.6. Blanking function

*(only in some models, see section 10 "List of available models")*

The Blanking function deactivates a specific zone of the detection field in order to guarantee that the presence of an object in this area does not interrupt the functioning of the controlled machine.

Two Blanking modes can be configured: Floating Blanking and Fixed Blanking.

These modes can be activated singularly or contemporarily.

**6.6.1. Floating Blanking**

Allows the Blanking of 1, 2 or 3 beams positioned in any zone of the detection area. Dip-switches 1 and 2 configure the number of beams to deactivate.

**Floating blanking OFF**

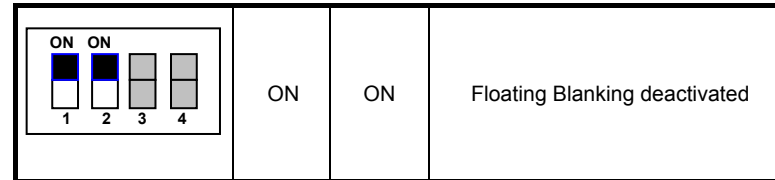

**Note:** Floating Blanking can not be applied on the first top beam as it carries-out the synchronism functions. If an object interrupts the first beam during functioning, even if Floating Blanking is activated, the OSSD outputs open and the light curtain enters into the BREAK status.

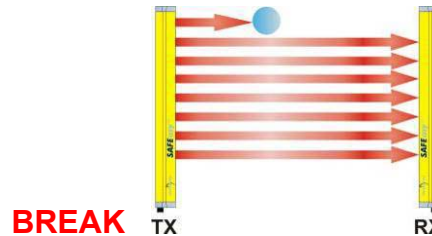

**Safety distance change**

The activation of the Floating Blanking function provokes a reduction of the device resolution. Consequently, the safety distance has to be recalculated according to the real device resolution (see table in section 2.2.1).

English

### Blanking lamp

The Floating Blanking activation is signalled by two LEDs positioned on the top of the receiving unit. The LEDs continue to blink for the entire duration of the Floating Blanking.

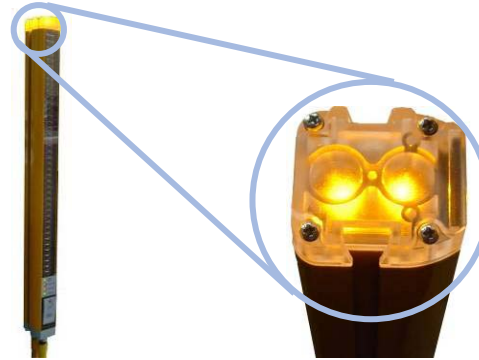

### Display LED for Floating Blanking signalling

Display LED	Status
<ul style="list-style-type: none"> <li><span style="color: green;">●</span> SAFE BREAK <i>Green ON</i></li> <li><span style="color: black;">●</span> HIGH ALIGN <i>OFF</i></li> <li><span style="color: yellow;">●</span> LOW ALIGN <i>Yellow ON</i></li> <li><span style="color: green;">●</span> POWER ON <i>Green ON</i></li> </ul>	The light curtain is ON and the Floating Blanking function is activated.
<ul style="list-style-type: none"> <li><span style="color: green;">●</span> SAFE BREAK <i>Green ON</i></li> <li><span style="color: yellow;">●</span> HIGH ALIGN <i>Yellow blinking</i></li> <li><span style="color: yellow;">●</span> LOW ALIGN <i>Yellow ON</i></li> <li><span style="color: green;">●</span> POWER ON <i>Green ON</i></li> </ul>	The Floating Blanking function is activated and an object is interrupting beams in the controlled area.

6.6.2. Floating Blanking - 1 beam

	ON	OFF	Floating Blanking activated, 1 beam deactivated. All objects interrupting more than 1 beam are detected.
--	----	-----	---

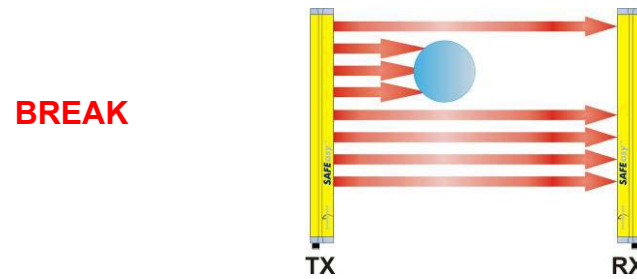
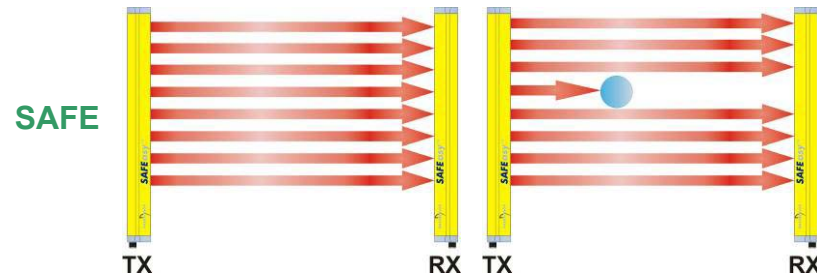

English

## 6.6.3. Floating Blanking – 2 beams

	Off	On	Floating Blanking activated, 2 beams deactivated. All objects interrupting a number of beams different from 2 are detected.
--	-----	----	--

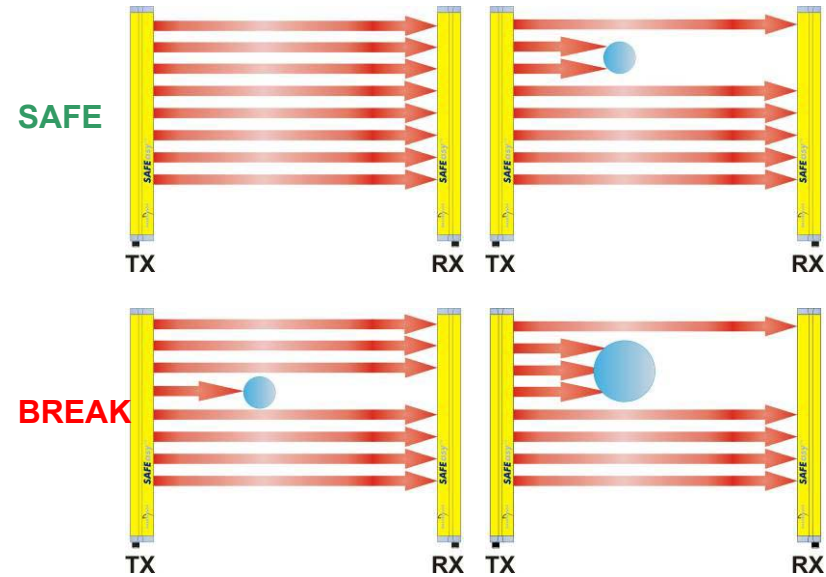

The interruption of a number of beams, different from two (i.e. more or less than two), provokes the activation of the OSSD outputs of the safety light curtain.

6.6.4. Floating Blanking – upto 3 beams (reduced resolution)

	Off	Off	Floating Blanking activated, 1, 2 or 3 adjacent beams deactivated. Blanking is activated up to the interruption of 3 beams. All objects interrupting more than 3 beams are detected.
--	-----	-----	--

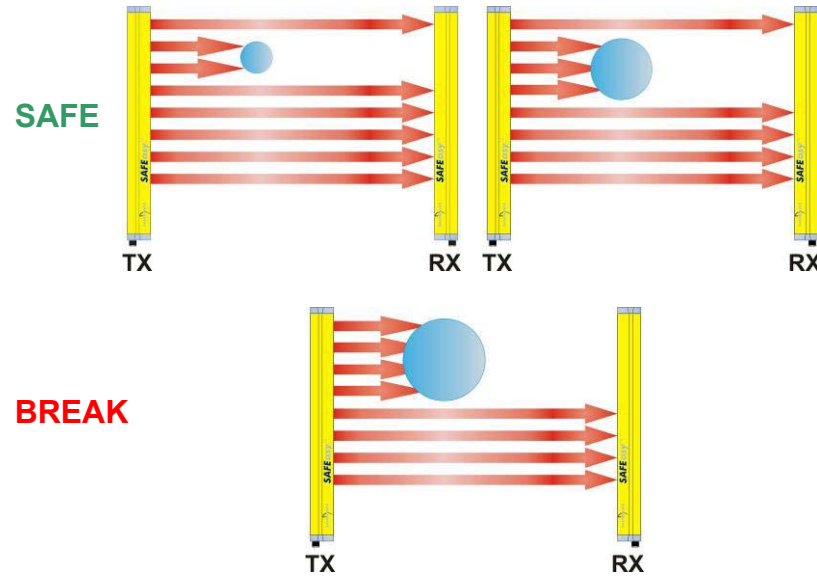

English

Differently from the other applications, this configuration accepts all objects that interrupt upto 3 beams and not only those exactly respecting the condition.

### 6.6.5. Fixed Blanking

Allows the Blanking of a pre-set and fixed part of the controlled area.



The position of the first beam involved and the dimensions of the area to deactivate have to be determined to guarantee the correct Blanking functioning.

The data is acquired by a TEACH-IN procedure, explained herein:

- To activate the TEACH-IN acquisition, a 24 Vdc voltage has to be applied for at least 3 sec on pin 3 (green) of the receiver M12 8-pole connector. This function is usually controlled by a push-button. For now onwards, a “pressed push-button” condition refers to the application of the 24 Vdc voltage on the input and “released push-button” condition refers to a 0 Vdc voltage (TEACH-IN deactivated). The TEACH-IN activation is signalled as follows:

 SAFE BREAK	<i>Red ON</i>
 HIGH ALIGN	<i>OFF</i>
 LOW ALIGN	<i>Yellow blinking</i>
 POWER ON	<i>Green ON</i>

- During TEACH-IN, keep the push-button pressed in order to continue the sequence. In this phase the OSSD outputs are deactivated.

- The acquisition of the necessary information is carried-out interrupting the beams on which the Blanking function has to be applied. Only one single Blanking area can be memorised and thus, during TEACH-IN, all the interrupted beams must be contiguous. If a beam is not deactivated inside the area to memorise, situation similar to the effort to memorise two different areas, the system enters in “ Blanking functioning failure” status (see table).

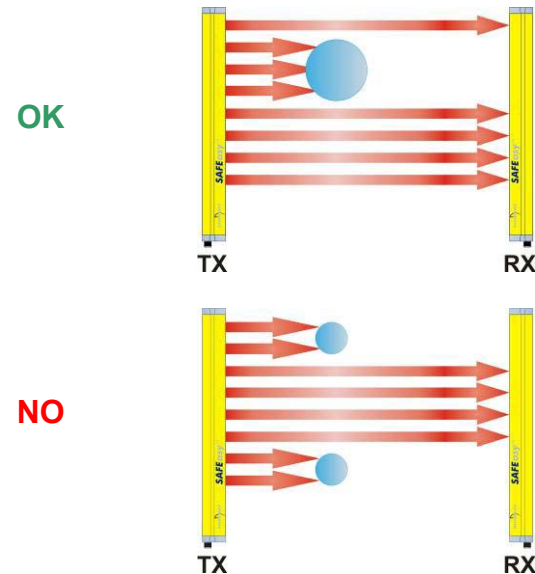

English

- The TEACH-IN is confirmed releasing the push-button. The OSSD outputs return active at the push-button releasing.

**Note:** TEACH-IN can not be applied on the first top beam as it carries-out the synchronism functions. If at the push-button release, the first beam is deactivated, the system enters into “Blanking functioning failure” status (see table on next page).

- A 1 minute Time-out period is foreseen in the TEACH-IN procedure. At the expiry the system enters into the “Blanking functioning failure” status (see *table*).

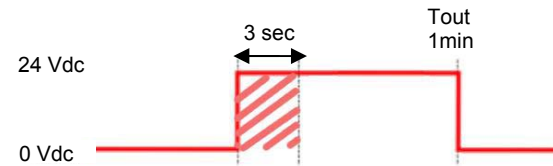

- The TEACH-IN procedure can be repeated during normal device functioning.
- The information acquired during TEACH-IN is memorised also after device powering off.
- A reset function of the TEACH-IN carried-out is not available. To guarantee the same result, the TEACH-IN function has to be repeated ensuring that all beams are free.
- An activation/deactivation function of the Fixed Blanking does not exist. A temporary deactivation can be obtained leaving the pin 3 (green) of the receiver's M12 8-pole unconnected.







**ATTENTION:** Fixed Blanking differently from Floating Blanking is not signalled by the safety light curtain. Consequently all the necessary precautions has to be taken before powering the device:

- Mount warning signs near the unprotected area to signal possible risks.
- Use protective stands and/or metal nets to avoid access, through the Blanking zone, into the machine dangerous area.



**NOTE:** A significant difference between the Fixed and Floating Blanking functions exists. Floating Blanking accepts that the number of beams forseen for Blanking is both interrupted as well as free (E.g.: the Blanking of 2 beams has been selected. During functioning two beams can be interrupted as well as none). In Fixed Blanking, the area memorised during TEACH-IN must always be obscured during functioning. Removing the object from the Blanking area, the light curtain enters in a “Blanking functioning error” status (see table on the bottom of the page).

**“Blanking functioning error” signal**

Display LED	Status
 SAFE BREAK OFF  HIGH ALIGN Yellow blinking  LOW ALIGN OFF  POWER ON Green ON	Error status due to an irregularity during the TEACH-IN phase of Fixed Blanking. To reset normal functioning, keep the TEST/START push-button pressed for at least 5 seconds. Reset provokes the cancelling of all the TEACH-IN previously carried-out.

English

**6.6.6. Fixed Blanking tolerance**

A tolerance on the memorised Blanking area can be activated applying a 24 Vdc voltage on pin 8 of the receiver M12 8-pole connector. The tolerance allows the movement of the object with TEACH-IN equal to one beam. To activate the tolerance, the second and last beam are not included in the Blanking area memorised to avoid functioning failure. If the second or last beam are included in the Blanking area, the tolerance will be in any case deactivated.

This option is particularly useful in presence of vibrations able to move the object detected with the TEACH-IN procedure.

### 6.7. Cascade configuration

*(only in some models, see section 10 "List of available models")*

The system allows Cascade connection of the two light curtain units, which are denominated respectively Master and Slave.

The single units maintain the same Test and Diagnostic procedure, the same aspect and functioning.

The only difference consists in that the Slave unit does not have OSSD outputs. The Master unit guides the outputs in accordance to its status and that of Slave.

The Master and Slave connection is carried-out connecting the emitter and receiver of both units using the M12 5-pole connector.

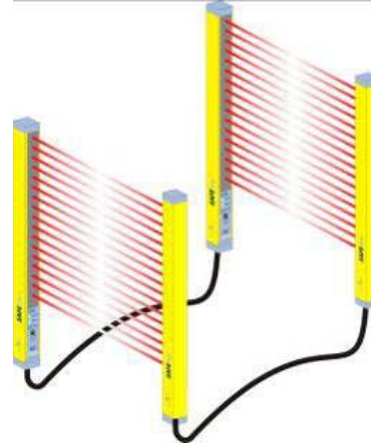

The Master recognises the Slave at powering and thus the connections have to be made before device powering.



### 6.7.1. Stand-Alone Master

The Master unit can be used separately from the Slave unit (the contrary is not possible). For correct device functioning, connect the specific electrical terminations to the M12 5-pole connectors assigned to the Master/Slave connection.

The terminations are supplied together with the Master unit and provide-out the following connection:

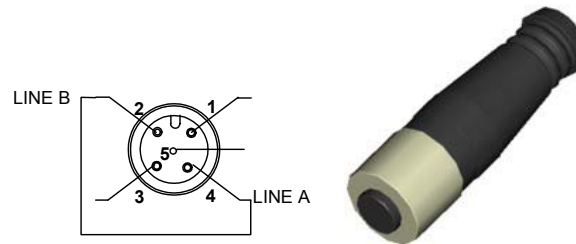

English

### 6.7.2. Alignment

The alignment procedure of the single unit (Master or Slave) is not very different from the standard procedure described in section 5.1.

The LEDs, in the Cascade configuration, signal alignment only when the Master and Slave are both correctly aligned.

It is thus impossible to distinguish whether the single unit, Master or Slave, is not aligned correctly. We suggest consequently to divide the procedure in two different phases:

- **Master alignment:** carry-out the alignment procedure of only the Master unit according to the standard procedure (see section 5.1), connecting the electrical terminations instead of the Slave unit.
- In presence of correct alignment, fix the Master and remove power supply.
- Replace the electrical termination with the Master/Slave connection cables.
- **Slave alignment:** the standard alignment procedure can now be carried-out for the Slave unit. Aligned correctly the Master unit, the operator is certain that all LED signals are referred to the Slave alignment.

## 7. DIAGNOSTIC FUNCTIONS

### 7.1. Visualisation of the functions

The operator can visualise the operating condition of the light curtains through four LEDs positioned on the receiver unit and two LEDs on the emitter unit (Fig.21).

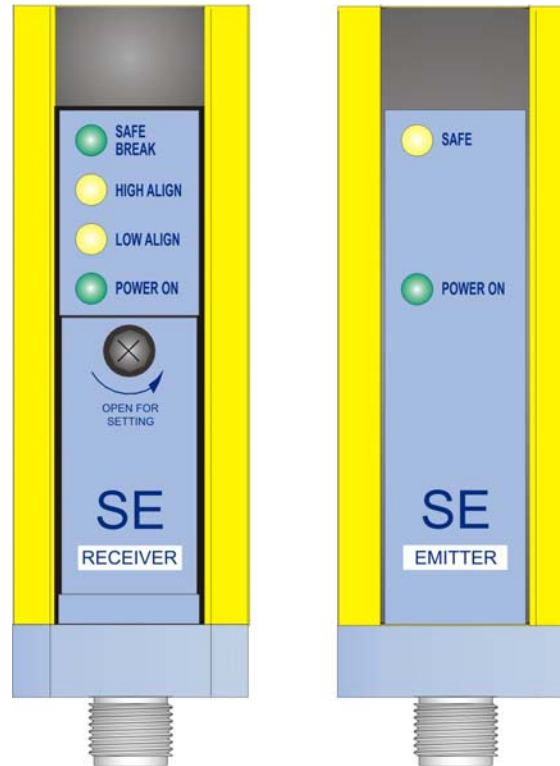





























Fig. 21

The reason for the LEDs positioned on the receiver unit (**RX**) depends on the functioning mode of the safety light curtain.

7.2. Fault and diagnostic messages

The operator is able to check the main causes of the system stop and failure, using the same LEDs used for the visualisation of the functions.

**RECEIVING UNIT:**

LED Status	Diagnostics	Check and Repair
 SAFE BREAK  HIGH ALIGN  LOW ALIGN  POWER ON Red blinking Yellow blinking Yellow blinking Green ON	Output failure	<ul style="list-style-type: none"> <li>- Check the output connections.</li> <li>- Check if the load characteristics are in accordance with the technical data (see section 9)</li> </ul>
 SAFE BREAK  HIGH ALIGN  LOW ALIGN  POWER ON OFF Yellow blinking Yellow blinking Green ON	Microprocessor failure	<ul style="list-style-type: none"> <li>- Check the correct positioning of the configuration dip-switches.</li> <li>- Switch OFF and switch ON the device; if the failure continues contact DATASENSOR</li> </ul>
 SAFE BREAK  HIGH ALIGN  LOW ALIGN  POWER ON OFF OFF Yellow blinking Green ON	Optic failure	<ul style="list-style-type: none"> <li>- Check unit alignment.</li> <li>- Switch OFF and switch ON the device; if the failure continues contact DATASENSOR</li> </ul>
 SAFE BREAK  HIGH ALIGN  LOW ALIGN  POWER ON Red blinking OFF Yellow blinking Green ON	Failure of external switching device (EDM test function)	<ul style="list-style-type: none"> <li>- Control the EDM connections</li> <li>- Check the compatibility of external switching device with EDM test time</li> <li>- Switch OFF and switch ON the devices; if failure persists replace external switching device</li> </ul>
 SAFE BREAK  HIGH ALIGN  LOW ALIGN  POWER ON OFF OFF OFF OFF	Power supply failure	<ul style="list-style-type: none"> <li>- Check power supply.</li> <li>- If the failure continues contact DATASENSOR</li> </ul>
 SAFE BREAK  HIGH ALIGN  LOW ALIGN  POWER ON OFF OFF OFF Green ON	The power supply voltage is outside the allowed range.	<ul style="list-style-type: none"> <li>- Check power supply.</li> <li>- Switch OFF and switch ON the device; if the failure continues contact DATASENSOR</li> </ul>
 SAFE BREAK  HIGH ALIGN  LOW ALIGN  POWER ON OFF Yellow blinking OFF Green ON	Blanking functioning failure	<ul style="list-style-type: none"> <li>- Control the correct object position memorised during TEACH-IN</li> <li>- Control the integrity of the TEACH-IN wire</li> </ul>

English

LED Status	Diagnostics	Check and Repair
OFF Yellow <i>blinking</i> Yellow <i>blinking</i> Green ON	Cascade configuration failure	<ul style="list-style-type: none"> <li>- Time-out communication, Master/Slave expired</li> <li>- Control the integrity of the Master/Slave connection</li> </ul>
Red OFF Yellow <i>blinking</i> OFF Green ON	Interlock status signal	Manual reset mode: signalling of one or more beam interruption. The Test/Start button has to be pressed to reset normal functioning.
Green ON OFF Yellow ON Green ON	Floating Blanking functioning activation signal	
Green ON Yellow <i>blinking</i> Yellow <i>blinking</i> Green ON	Floating Blanking functioning signal	Floating Blanking function activated and an object is interrupting some beams inside the detection area. Floating blanking is functioning.
Red ON OFF Yellow <i>blinking</i> Green ON	TEACH-IN status signal	

**EMITTING UNIT:**

Failure	Cause	Check and Repair
Yellow <i>blinking</i> Green ON	Functioning failure	<ul style="list-style-type: none"> <li>- Check the power supply</li> <li>- If the failure continues contact DATASENSOR and replace both units</li> </ul>
OFF OFF	Power supply failure	<ul style="list-style-type: none"> <li>- Check the power supply</li> <li>- If the failure continues contact DATASENSOR and replace both units</li> </ul>
OFF Green ON	The power supply voltage is outside the allowed range	<ul style="list-style-type: none"> <li>- Check the power supply</li> <li>- If the failure continues contact DATASENSOR and replace both units</li> </ul>

## 8. CHECKS AND PERIODICAL MAINTENANCE

The following is a list of recommended check and maintenance operations that should be periodically carried-out by qualified personnel.

Check that:

- The ESPE stays locked during beam interruption along the entire protected area, using the suitable “Test Piece”.
- Pressing the TEST/START button, the OSSD outputs should open (the red BREAK LED is ON and the controlled machine stops).
- The response time at the machine STOP (including response time of the ESPE and of the machine) is within the limits defined by the calculation of the safety distance (see section 2 “Installation Mode”).
- The safety distance between the dangerous areas and the ESPE are in accordance with the instructions included in section 2 “Installation Mode”.
- Access to the dangerous area of the machine from any unprotected area is not possible .
- The ESPE and the external electrical connections are not damaged.

The frequency of checks depends on the particular application and on the operating conditions of the safety light curtain.

### 8.1. Maintenance

The **SAFEasy**<sup>™</sup> SE4-PLUS safety devices do not require any particular maintenance, with the exception of the cleaning of the protection front surfaces of the optics.

When cleaning, use a cotton cloth dampened with water.



**Do not under any circumstances use:**

- alcohol or solvents
- wool or synthetic cloths

### 8.2. General information and useful data



The safety devices fulfil their safety function only if they are correctly installed, in accordance with the Standards in force. If you are not certain to have the expertise necessary to install the device in the correct way, DATASENSOR Technical Service is at your disposal to carry-out the installation.

Auto-regenerating type fuses are used. Consequently, in presence of a short-circuit, these fuses protect the device. After the intervention of the fuses, it is necessary to disconnect the power supply and wait for 20 seconds so that the fuses can automatically restart normal functioning.

A power failure caused by interferences may cause the temporary opening of the outputs, but the safe functioning of the light curtain will not be compromised.

### 8.3. Warranty

All appliances are under a 36 month warranty from the manufacturing date.

DATASENSOR will not be liable for any damages to persons and things caused by the non-observance of the correct installation modes and device use.

The warranty will not cover damages caused by incorrect installation, incorrect use and accidental causes such as bumps or falls.



In presence of a non-functioning device, always return the emitting and receiving units for repair or replacement.

In presence of failures send the both units to DATASENSOR S.p.A.

#### **Sales Technical Service**

Tel.: +39 051 6765611

Fax: +39 051 6759324

email: [service@datasensor.com](mailto:service@datasensor.com)



## 10. LIST OF AVAILABLE MODELS

Model	Description	N° beams	Resolution (mm)	Response time (ms)	Operating distance (m)			
SE4-14-015-PP-E	Finger protection EDM	21	<b>14</b>	14	<b>0.2....6</b>			
SE4-14-030-PP-E		42		18				
SE4-14-045-PP-E		63		22				
SE4-14-060-PP-E		84		26				
SE4-14-075-PP-E		105		30				
SE4-14-090-PP-E		126		34				
SE4-14-105-PP-E		147		38				
SE4-14-120-PP-E		168		41				
SE4-30-015-PP-E		Hand protection EDM		8		<b>30</b>	12	<b>0.2...15</b>
SE4-30-030-PP-E	16		13					
SE4-30-045-PP-E	24		15					
SE4-30-060-PP-E	32		16					
SE4-30-075-PP-E	40		18					
SE4-30-090-PP-E	48		19					
SE4-30-105-PP-E	56		21					
SE4-30-120-PP-E	64		22					
SE4-30-135-PP-E	72		24					
SE4-30-150-PP-E	80		25					
SE4-30-165-PP-E	88		26					
SE4-14-015-PP-B	Finger protection BLANKING		21	<b>14</b>	21		<b>0.2....6</b>	
SE4-14-030-PP-B			42		28			
SE4-14-045-PP-B			63		35			
SE4-14-060-PP-B		84	41					
SE4-14-075-PP-B		105	48					
SE4-14-090-PP-B		126	55					
SE4-14-105-PP-B		147	62					
SE4-14-120-PP-B		168	68					
SE4-30-015-PP-B		Hand protection BLANKING	8		<b>30</b>	16		<b>0.2...15</b>
SE4-30-030-PP-B	16		20					
SE4-30-045-PP-B	24		23					
SE4-30-060-PP-B	32		25					
SE4-30-075-PP-B	40		27					
SE4-30-090-PP-B	48		30					
SE4-30-105-PP-B	56		32					
SE4-30-120-PP-B	64		35					
SE4-30-135-PP-B	72		38					
SE4-30-150-PP-B	80		40					
SE4-30-165-PP-B	88		43					

Model	Description	N° beams	Resolution (mm)	Response time (ms)	Operating distance (m)
SE4-14-015-PP-M	Finger protection MASTER	21	14	21	0.2....6
SE4-14-030-PP-M		42		28	
SE4-14-045-PP-M		63		35	
SE4-14-060-PP-M		84		41	
SE4-14-075-PP-M		105		48	
SE4-14-090-PP-M		126		55	
SE4-14-105-PP-M		147		62	
SE4-14-120-PP-M		168		68	
SE4-30-015-PP-M	Hand protection MASTER	8	30	16	0.2...15
SE4-30-030-PP-M		16		20	
SE4-30-045-PP-M		24		23	
SE4-30-060-PP-M		32		25	
SE4-30-075-PP-M		40		27	
SE4-30-090-PP-M		48		30	
SE4-30-105-PP-M		56		32	
SE4-30-120-PP-M		64		35	
SE4-30-135-PP-M		72		38	
SE4-30-150-PP-M		80		40	
SE4-30-165-PP-M		88		43	
SE4-14-015-PP-N	Finger protection MASTER BLANKING	21	14	21	0.2....6
SE4-14-030-PP-N		42		28	
SE4-14-045-PP-N		63		35	
SE4-14-060-PP-N		84		41	
SE4-14-075-PP-N		105		48	
SE4-14-090-PP-N		126		55	
SE4-14-105-PP-N		147		62	
SE4-14-120-PP-N		168		68	
SE4-30-015-PP-N	Hand protection MASTER BLANKING	8	30	16	0.2...15
SE4-30-030-PP-N		16		20	
SE4-30-045-PP-N		24		23	
SE4-30-060-PP-N		32		25	
SE4-30-075-PP-N		40		27	
SE4-30-090-PP-N		48		30	
SE4-30-105-PP-N		56		32	
SE4-30-120-PP-N		64		35	
SE4-30-135-PP-N		72		38	
SE4-30-150-PP-N		80		40	
SE4-30-165-PP-N		88		43	

English

Model	Description	N° beams	Resolution (mm)	Response time (ms)	Operating distance (m)
SE4-14-015-PP-S	Finger protection SLAVE	21	<b>14</b>	21	<b>0.2....6</b>
SE4-14-030-PP-S		42		28	
SE4-14-045-PP-S		63		35	
SE4-14-060-PP-S		84		41	
SE4-14-075-PP-S		105		48	
SE4-14-090-PP-S		126		55	
SE4-14-105-PP-S		147		62	
SE4-14-120-PP-S		168		68	
SE4-30-015-PP-S	Hand protection SLAVE	8	<b>30</b>	16	<b>0.2...15</b>
SE4-30-030-PP-S		16		20	
SE4-30-045-PP-S		24		23	
SE4-30-060-PP-S		32		25	
SE4-30-075-PP-S		40		27	
SE4-30-090-PP-S		48		30	
SE4-30-105-PP-S		56		32	
SE4-30-120-PP-S		64		35	
SE4-30-135-PP-S		72		38	
SE4-30-150-PP-S		80		40	
SE4-30-165-PP-S		88		43	

11. DIMENSIONS

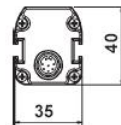
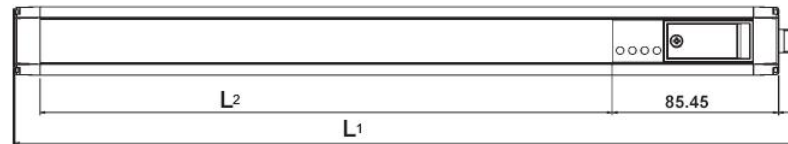
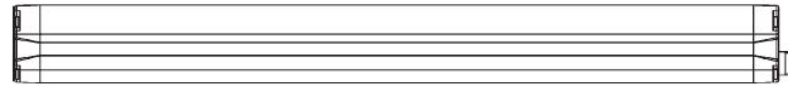

English

MODEL	L1 (mm)	L2 (mm)
SE4-xx-015-PP-y	256	147
SE4-xx-030-PP-y	403	294
SE4-xx-045-PP-y	550	441
SE4-xx-060-PP-y	697	588
SE4-xx-075-PP-y	844	735
SE4-xx-090-PP-y	991	882
SE4-xx-105-PP-y	1138	1029
SE4-xx-120-PP-y	1285	1176
SE4-xx-135-PP-y	1432	1323
SE4-xx-150-PP-y	1579	1470
SE4-xx-165-PP-y	1726	1617

xx = resolution (14 mm – 30 mm)  
 y = EDM, Blanking, Cascade models

## 12. ACCESSORIES

### Fixing brackets

A MOUNTING

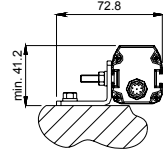

B MOUNTING

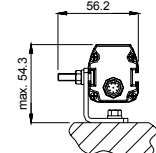

Angled fixing bracket

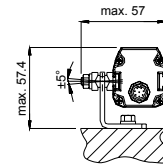
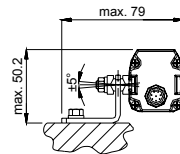

Angled fixing bracket + Orientable support

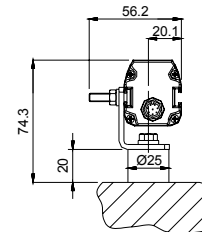
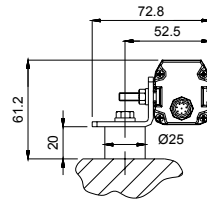

Angled fixing bracket + Antivibration support

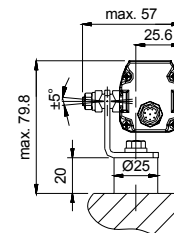
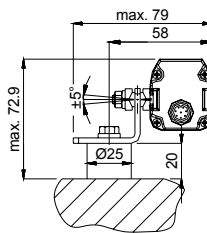

Angled fixing bracket + Orientable support + Antivibration support

**MODEL**

**DESCRIPTION**

ST-KSTD	Fixing brackets for angle mounting (4 pcs kit)
ST-K4AV	Antivibration support (4 pcs kit)
ST-K6AV	Antivibration support (6 pcs kit)
ST-K4OR	Orientable support (4 pcs kit)
ST-K6OR	Orientable support (6 pcs kit)

Deviating mirrors

MODEL	DESCRIPTION	L <sub>1</sub> (mm)	L <sub>2</sub> (mm)
SE-DM 150	Deviating mirror H= 150 mm	-	-
SE-DM 500	Deviating mirror H= 550 mm	554	384
SE-DM 600	Deviating mirror H= 700 mm	704	534
SE-DM 800	Deviating mirror H= 900 mm	904	734
SE-DM 900	Deviating mirror H= 1000 mm	1004	834
SE-DM 1200	Deviating mirror H= 1270 mm	1264	1094
SE-DM 1500	Deviating mirror H= 1600 mm	1604	1434
SE-DM 1650	Deviating mirror H= 1800 mm	1804	1634

English

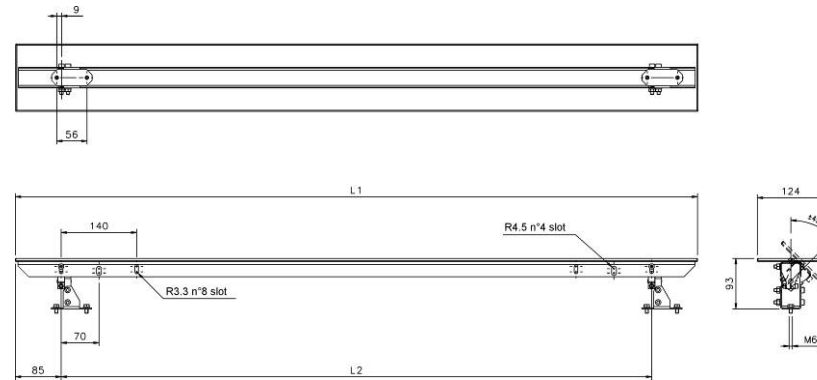

SE-DM 150

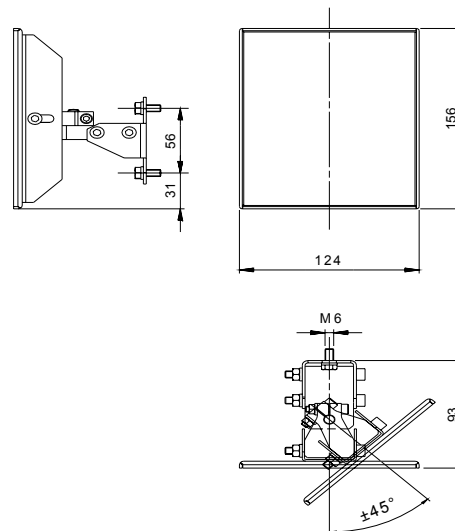

## Columns and floor stands

MODEL	DESCRIPTION	L (mm)	X (mm)
SE-S 800	Column and floor stand H= 800 mm	800	30x30
SE-S 1000	Column and floor stand H= 1000 mm	1000	30x30
SE-S 1200	Column and floor stand H= 1200 mm	1200	30x30
SE-S 1500	Column and floor stand H= 1500 mm	1500	45x45
SE-S 1800	Column and floor stand H= 1800 mm	1800	45x45

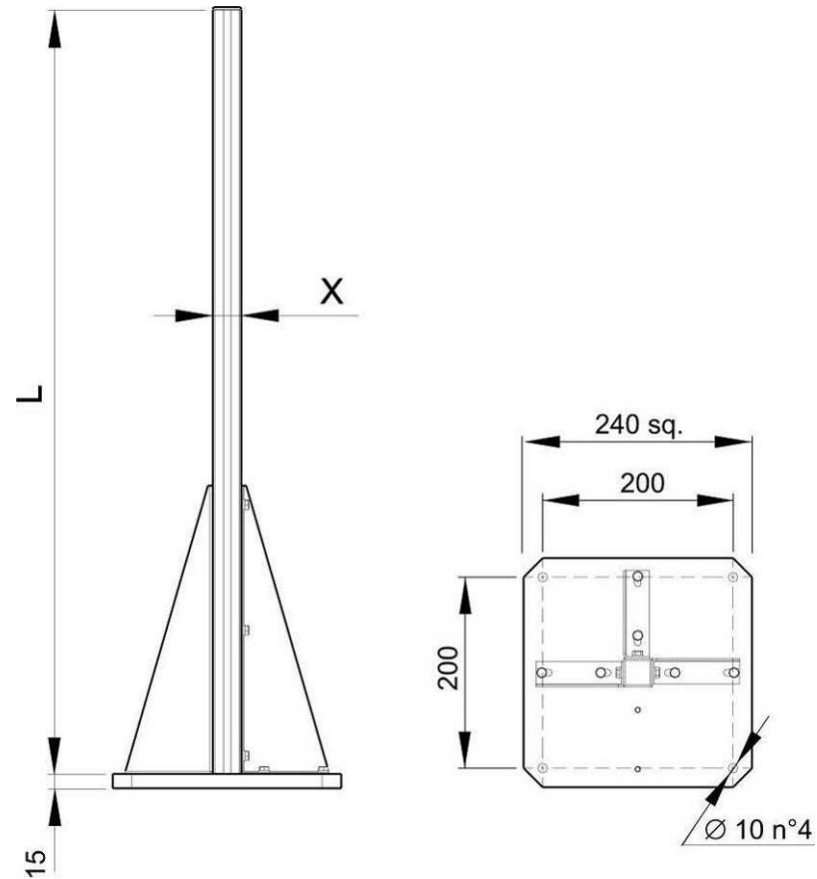

**Protective stands**

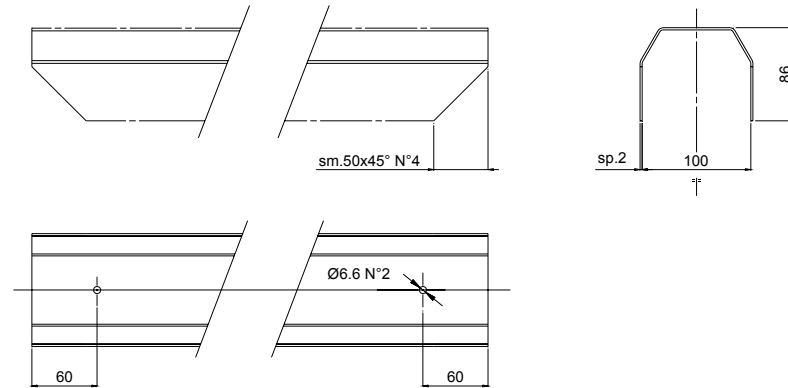

English

MODEL	DESCRIPTION	L (mm)
SE-P 150	Protective stand H= 273 mm	273
SE-P 300	Protective stand H= 420 mm	420
SE-P 450	Protective stand H= 567 mm	567
SE-P 600	Protective stand H= 714 mm	714
SE-P 750	Protective stand H= 861 mm	861
SE-P 800	Protective stand H= 969 mm	969
SE-P 900	Protective stand H= 1069 mm	1069
SE-P 1050	Protective stand H= 1155 mm	1155
SE-P 1200	Protective stand H= 1302 mm	1369
SE-P 1350	Protective stand H= 1449 mm	1449
SE-P 1500	Protective stand H= 1596 mm	1596
SE-P 1650	Protective stand H= 1743mm	1743

**Test piece**

MODEL	DESCRIPTION
TP-14	Test piece Ø 14 mm
TP-20	Test piece Ø 20 mm
TP-30	Test piece Ø 30 mm
TP-35	Test piece Ø 35 mm

**Connection cables**

MODEL	DESCRIPTION
CV-A1-22-B-03	Axial shielded 4-pin 3 m cable
CV-A1-22-B-05	Axial shielded 4-pin 5 m cable
CV-A1-22-B-10	Axial shielded 4-pin 10 m cable
CV-A1-22-B-15	Axial shielded 4-pin 15 m cable
CV-A1-22-B-25	Axial shielded 4-pin 25 m cable
CV-A1-26-B-03	Axial shielded 8-pin 3 m cable
CV-A1-26-B-05	Axial shielded 8-pin 5 m cable
CV-A1-26-B-10	Axial shielded 8-pin 10 m cable
CV-A1-26-B-15	Axial shielded 8-pin 15 m cable
CV-A1-26-B-25	Axial shielded 8-pin 25 m cable
CV-A2-22-B-03	Radial shielded 90° 4-pin 3 m cable
CV-A2-22-B-05	Radial shielded 90° 4-pin 5 m cable
CV-A2-22-B-10	Radial shielded 90° 4-pin 10 m cable
CV-A2-26-B-03	Radial shielded 90° 8-pin 3 m cable
CV-A2-26-B-05	Radial shielded 90° 8-pin 5 m cable
CV-A2-26-B-10	Radial shielded 90° 8-pin 10 m cable

**Master Slave connection cables for Cascade versions**

MODEL	DESCRIPTION
CV-A1-23-B-0005-2F	5-pole M12 double connector with 0.5 m cable*
CV-A1-23-B-01-2F	5-pole M12 double connector with 1 m cable*
SE-C	5-pole M12 connector for Master termination**

\* 0.5 m or 1 m shielded cables with 5-pole M12 connector for the Master and Slave connection must be ordered in combination with the **SE4-PLUS Cascade** light curtains.

\*\* The 5-pole M12 connector for the Master termination (SE-C accessory) has to be connected instead of the Slave during the alignment phase of the Master unit.  
Once aligned and definitively mounted, the Master has to be disconnected from the SE-C termination connector. The Slave has to be then connected and aligned.  
Moreover, the termination connector has to be definitively inserted if a Master couple is to be used singularly, that is without a Slave couple.

**Note:** a couple of SE-C termination connectors are supplied with **SE4-PLUS Cascade** light curtains.

**Safety relay**

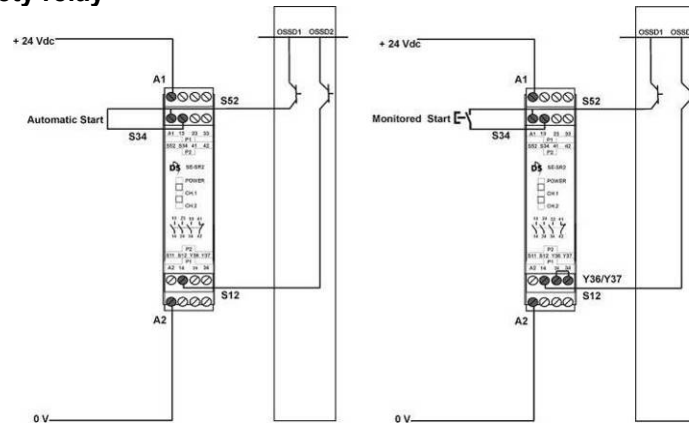

English

The drawing shows the connection between the SAFEasy™ safety light curtain and the Type 4 safety relay of the SE-SR2 series functioning in the automatic Restart mode (left side) and manual Restart with monitoring (right side).

MODEL	DESCRIPTION
SE-SR2	Type 4 safety relay - 3 NO 1NC

**Laser pointer**

The laser pointer of the SE-LP series represents a valid alignment and installation support for the SE safety light curtain series. The pointer can be moved along the light curtain profile to verify the complete device alignment (top and bottom).

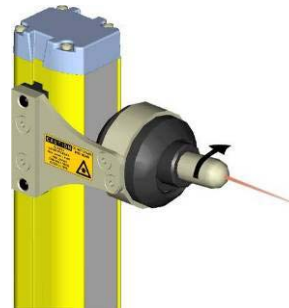

MODEL	DESCRIPTION
SE-LP	Laser pointer